

PI85T with socket GZT80-V0

relays for railroad industry - interface

RM85 + GZT80-V0



- Relays designed for continuous operation* • 35 mm rail mount acc. to EN 60715 or on panel mounting with one M3 screw
- Compliance with standards: EN 45545-2 (category EL10, requirement R26 - flammability class V-0 acc. to EN 60695-11-10); EN 61373 category 1, class B (mechanical shock and vibration resistance); EN 50155; EN 60077-1; EN 61810-1
- Recognitions, certifications, directives: recognitions RM85, RoHS,



Contact data

Number and type of contacts		1 CO
Contact material		AgSnO₂
Rated / max. switching voltage	AC	250 V / 300 V
Min. switching voltage		10 V
Rated load (capacity)	AC1	16 A / 250 V AC ❶
	AC15	3 A / 120 V 1,5 A / 240 V (B300)
	DC1	16 A / 24 V DC (see Fig. 3)
	DC13	0,22 A / 120 V 0,1 A / 250 V (R300)
Motor load	acc. to UL 508	1/2 HP 240 V AC, 4,9 FLA, single-phase motor ❷
	AC3 acc. to IEC 60947-4-1	0,5 kW 240 V AC, single-phase motor
Min. switching current		10 mA
Max. make current		30 A
Rated current		16 A
Max. breaking capacity	AC1	4 000 VA
Min. breaking capacity		1 W
Contact resistance		≤ 100 mΩ 1 A, 24 V
Max. operating frequency		
• at rated load	AC1	600 cycles/hour
• no load		72 000 cycles/hour

Coil data

Rated voltage	DC	24 , 110 V ❸
Must release voltage		≥ 0,1 U _n
Operating range of supply voltage		0,7...1,25 U _n EN 50155 see Table 1
Must operate voltage		≤ 0,7 U _n
Rated power consumption	DC	0,4 ... 0,48 W

Insulation according to EN 60664-1

Insulation rated voltage		250 V AC
Rated surge voltage		4 000 V 1,2 / 50 μs
Overvoltage category		III
Insulation pollution degree		3
Flammability class		V-0 UL 94, EN 60695-11-10
Dielectric strength		
• between coil and contacts		5 000 V AC type of insulation: reinforced
• contact clearance		1 000 V AC type of clearance: micro-disconnection
Contact - coil distance	• clearance	≥ 10 mm
	• creepage	≥ 10 mm

General data

Operating / release time (typical values)		7 ms / 3 ms
Electrical life		
• resistive AC1		> 0,7 x 10 ⁵ 16 A, 250 V AC
• cosφ		see Fig. 2
• DC L/R=40 ms		> 10 ⁵ 0,12 A, 220 V DC
Mechanical life (cycles)		> 3 x 10 ⁷
Dimensions (L x W x H)		80 x 15,6 x 61 mm
Weight		62 g
Ambient temperature	• storage	-40...+85 °C
(non-condensation and/or icing)	• operating	-40...+55 °C
Cover protection category		IP 20 EN 60529
Environmental protection		RM85: RTII GZT80-V0: RT0 EN 61810-1
Shock / vibration resistance		category 1, class B EN 61373 (set: relay in socket with clip and module)

The data in bold type relate to the standard versions of the relays. *The relays are designed for continuous operation while maintaining the parameters declared in the data sheet. ❶ Loads above 12 A require bridging pairs of screw terminals: 11 with 21, 12 with 22, 14 with 24 - see page 2. ❷ For single phase motors for 110-120 V AC do not use motors with higher FLA than given for 240 V AC. ❸ For other voltages, please contact Relpol S.A.

PI85T with socket GZT80-V0

relays for railroad industry - interface

Electrical life at AC resistive load.
Switching frequency: 600 cycles/hour

Fig. 1

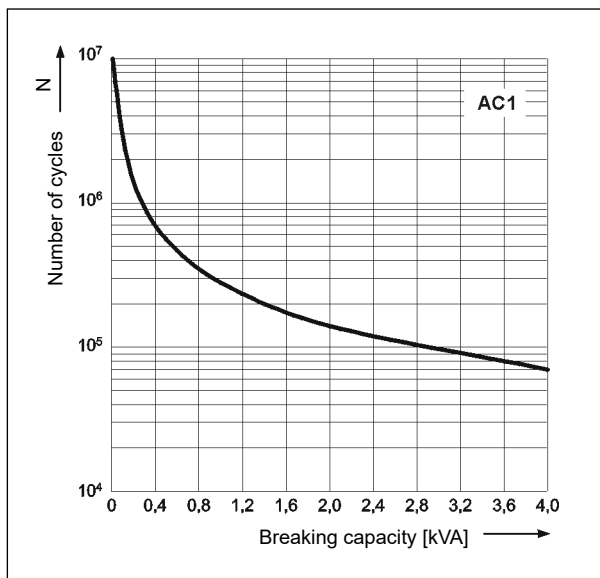

Electrical life reduction factor at AC inductive load

Fig. 2

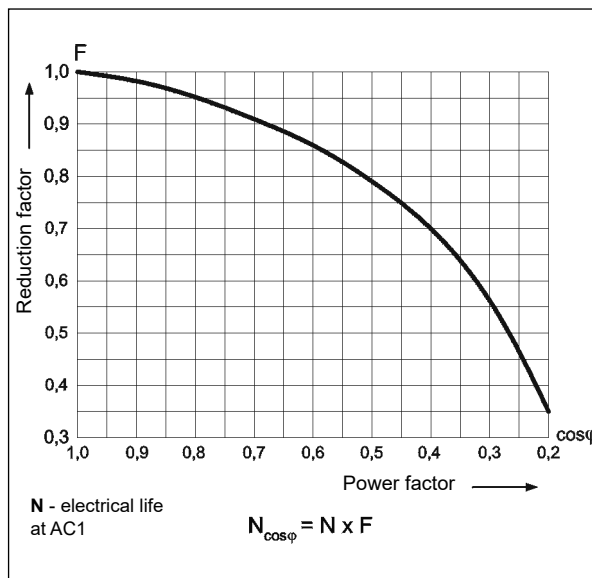

Max. DC resistive load breaking capacity

Fig. 3

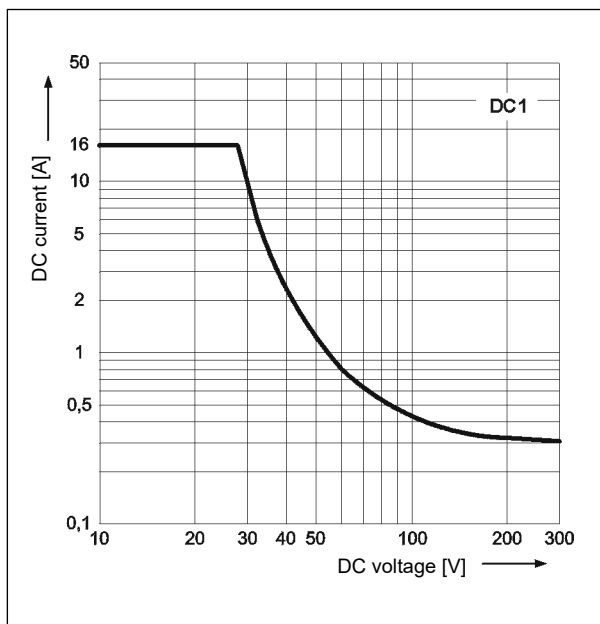

Dimensions

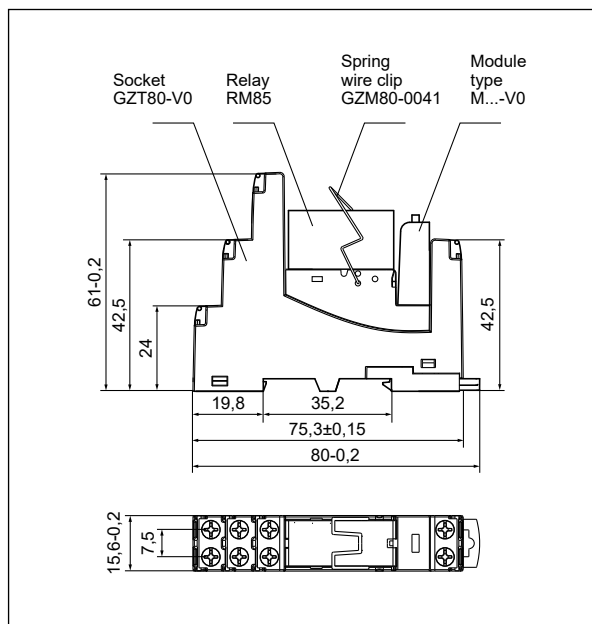

Mounting

Relays **PI85T with socket GZT80-V0** are designed for direct mounting on 35 mm rail mount acc. to EN 60715 or on panel mounting with one M3 screw. **Connections:** max. cross section of the cables (stranded): 2 x 2,5 mm² (2 x 14 AWG), stripping length: 6,5 mm, max. tightening moment for the terminal: 0,7 Nm.

PRECAUTIONS:

1. Ensure that the parameters of the product described in its specification provide a safety margin for the appropriate operation of the device or system and never use the product in circumstances which exceed the parameters of the product. 2. Never touch any live parts of the device. 3. Ensure that the product has been connected correctly. An incorrect connection may cause malfunction, excessive heating or risk of fire. 4. In case of any risk of any serious material loss or death or injuries of humans or animals, the devices or systems shall be designed so to equip them with double safety system to guarantee their reliable operation.

PI85T with socket GZT80-V0 relays for railroad industry - interface

Connection diagram (screw terminals side view)

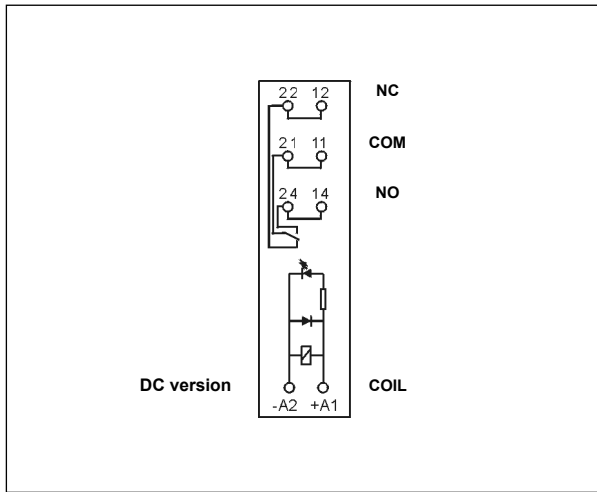

Connection of GZT80-V0 socket

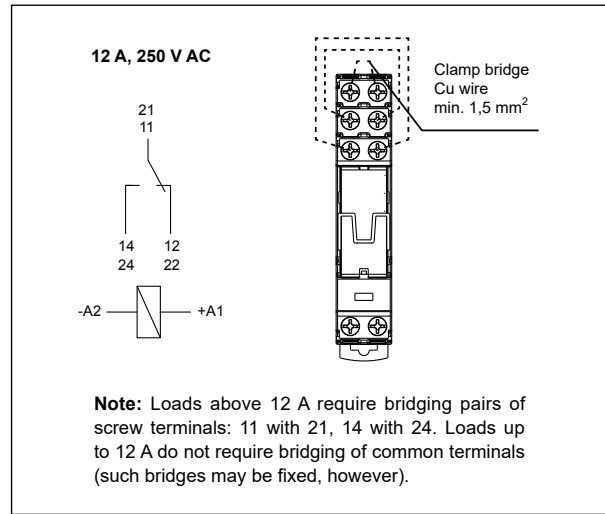

Coil data - DC voltage version

Table 1

Coil code	Rated voltage V DC ③	Coil resistance at 20 °C Ω	Acceptable resistance	Coil operating range V DC according to EN 50155 ④	
				min.	max.
024DC	24	1 440	± 10%	16,8	30,0
110DC	110	25 200	± 10%	77,0	137,5

The data in bold type relate to the standard versions of the relays. ③ For other voltages, please contact Relpol S.A. ④ Changes of voltage within the range 0,6...1,4 Un below 0,1 s and changes of voltage within the range 1,25...1,4 Un below 1 s are admissible and they do not distort operation of the relays.

Ordering codes

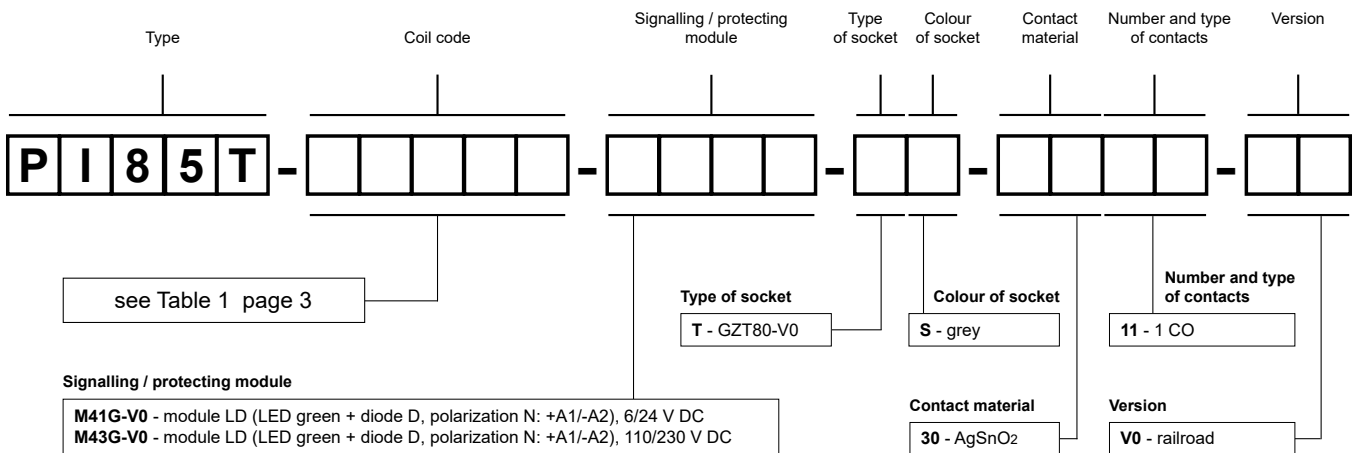

Examples of ordering codes:

PI85T-024DC-M41G-TS-3011-V0

interface relay **PI85T** (railroad version) consists of: relay **RM85** (one changeover contact, contact material AgSnO₂, coil voltage 24 V DC), socket **GZT80-V0** (grey, screw terminals), signalling / protecting module **M41G-V0** (version LD), spring wire clip **GZM80-0041**

PI85T-110DC-M43G-TS-3011-V0

interface relay **PI85T** (railroad version) consists of: relay **RM85** (one changeover contact, contact material AgSnO₂, coil voltage 110 V DC), socket **GZT80-V0** (grey, screw terminals), signalling / protecting module **M43G-V0** (version LD), spring wire clip **GZM80-0041**